

Single-Line ESD-Protection Diode in SOT-23

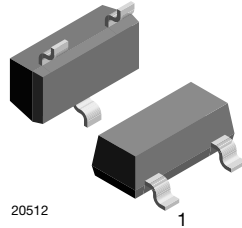

MARKING (example only)

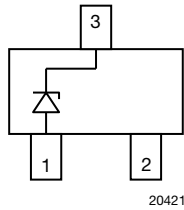
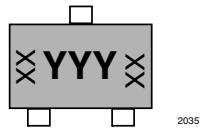

YYY = type code (see table below)

X = date code

FEATURES

- Single-line ESD-protection device
- ESD-immunity acc. IEC 61000-4-2
± 30 kV contact discharge
± 30 kV air discharge
- Space saving SOT-23 package
- AEC-Q101 qualified
- e3 - Sn
- Compliant to RoHS directive 2002/95/EC and in accordance to WEEE 2002/96/EC



ORDERING INFORMATION

DEVICE NAME	ENVIRONMENTAL STATUS	ORDERING CODE	TAPED UNITS PER REEL (8 mm TAPE ON 7" REEL)	MINIMUM ORDER QUANTITY
GSOT05L-V	Standard	GSOT05L-V-GS08	3000	15 000
	Green	GSOT05L-V-G-08		

PACKAGE DATA

DEVICE NAME	PACKAGE NAME	TYPE CODE	ENVIRONMENTAL STATUS	WEIGHT	MOLDING COMPOUND FLAMMABILITY RATING	MOISTURE SENSITIVITY LEVEL	SOLDERING CONDITIONS
GSOT05L-V	SOT-23	05L	Standard	8.8 mg	UL 94 V-0	MSL level 1 (according J-STD-020)	260 °C/10 s at terminals
		5LG	Green	8.1 mg			

ABSOLUTE MAXIMUM RATINGS GSOT05L-V

PARAMETER	TEST CONDITIONS	SYMBOL	VALUE	UNIT
Peak pulse current	Pin 3 to 1 acc. IEC 61000-4-5, 8/20 µs/single shot	I _{PPM}	13	A
Peak pulse power	Pin 3 to 1 acc. IEC 61000-4-5, 8/20 µs/single shot	P _{PP}	156	W
ESD immunity	Contact discharge acc. IEC 61000-4-2; 10 pulses	V _{ESD}	± 30	kV
	Air discharge acc. IEC 61000-4-2; 10 pulses		± 30	kV
Operating temperature	Junction temperature	T _J	- 40 to + 150	°C
Storage temperature		T _{STG}	- 55 to + 150	°C

** Please see document "Vishay Material Category Policy": www.vishay.com/doc?99902

BiAs-MODE (bidirectional asymmetrical protection mode)

With the GSOT05L-V one signal- or data-lines (L1) can be protected against voltage transients. With pin 1 connected to ground and pin 3 connected to a signal- or data-line which has to be protected. As long as the voltage level on the data- or signal-line is between 0 V (ground level) and the specified maximum reverse working voltage (V_{RWM}) the protection diode between data line and ground offers a high isolation to the ground line. The protection device behaves like an open switch.

As soon as any positive transient voltage signal exceeds the break through voltage level of the protection diode, the diode becomes conductive and shorts the transient current to ground. Now the protection device behaves like a closed switch. The clamping voltage (V_C) is defined by the breakthrough voltage (V_{BR}) level plus the voltage drop at the series impedance (resistance and inductance) of the protection device.

Any negative transient signal will be clamped accordingly. The negative transient current is flowing in the forward direction of the protection diode. The low forward voltage (V_F) clamps the negative transient close to the ground level.

Due to the different clamping levels in forward and reverse direction the GSOT05L-V clamping behaviour is bidirectional and asymmetrical (BiAs).



20422

ELECTRICAL CHARACTERISTICS GSOT05L-V						
PARAMETER	TEST CONDITIONS/REMARKS	SYMBOL	MIN.	TYP.	MAX.	UNIT
Protection paths	Number of lines which can be protected	N_{lines}	-	-	1	lines
Reverse stand off voltage	at $I_R = 1 \mu A$	V_{RWM}	5.5	6.1	7	V
Reverse current	at $V_R = 5.5 V$	I_R	-	-	1	μA
Reverse breakdown voltage	at $I_R = 1 mA$	V_{BR}	6	6.75	-	V
Reverse clamping voltage	at $I_{PP} = 1 A$	V_C	-	6.9	9	V
	at $I_{PP} = I_{PPM} = 13 A$		-	10	12	V
Forward clamping voltage	at $I_{PP} = 1 A$	V_F	-	1	1.3	V
	at $I_{PP} = I_{PPM} = 13 A$		-	2.6	3	V
Capacitance	at $V_R = 0 V$; $f = 1 MHz$	C_D	-	100	120	pF
	at $V_R = 2.5 V$; $f = 1 MHz$		-	60	-	pF

Note

- Ratings at 25 °C, ambient temperature unless otherwise specified. BiAs mode (between pin 3 to 1).

TYPICAL CHARACTERISTICS ($T_{amb} = 25 \text{ }^\circ\text{C}$, unless otherwise specified)

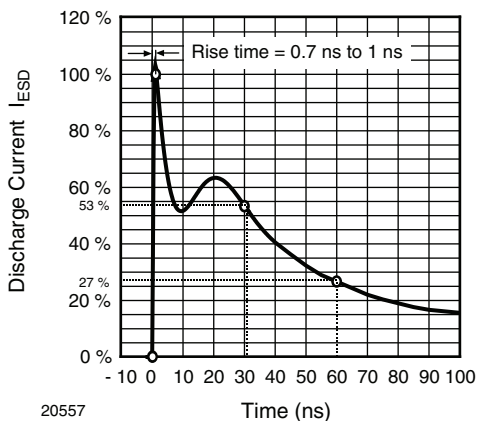

Fig. 1 - ESD Discharge Current Wave Form acc. IEC 61000-4-2 (330 Ω /150 pF)

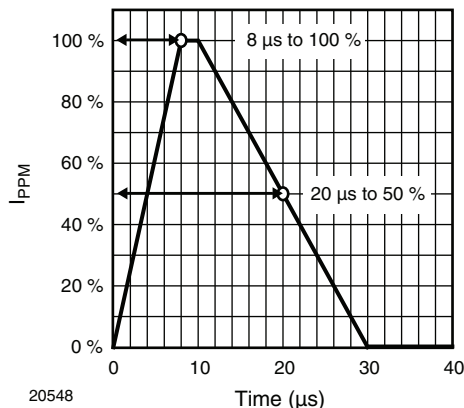

Fig. 2 - 8/20 μs Peak Pulse Current Wave Form acc. IEC 61000-4-5

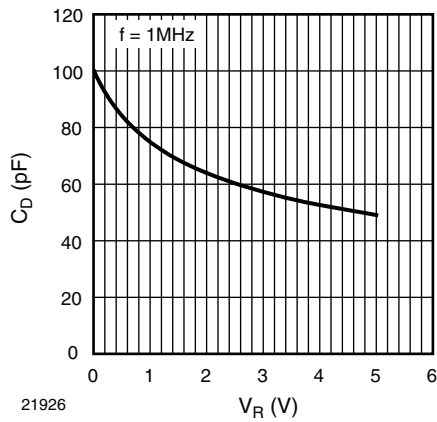

Fig. 3 - Typical Capacitance C_D vs. Reverse Voltage V_R

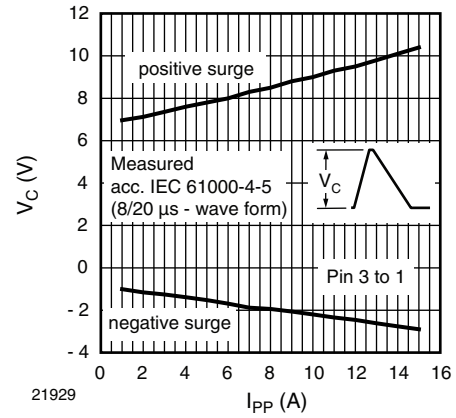

Fig. 6 - Typical Peak Clamping Voltage V_C vs. Peak Pulse Current I_{PP}

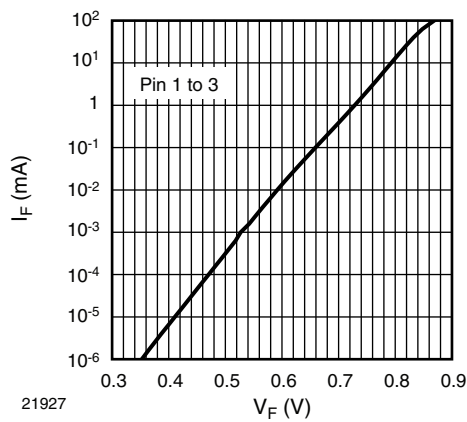

Fig. 4 - Typical Forward Current I_F vs. Forward Voltage V_F

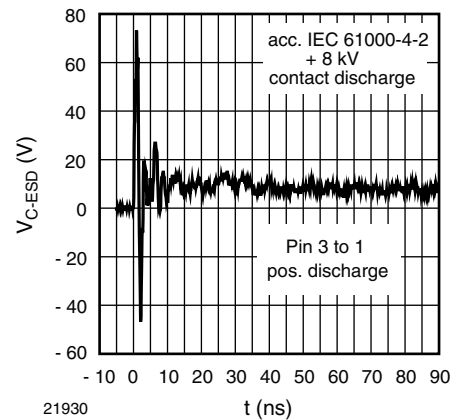

Fig. 7 - Typical Clamping Performance at +8 kV Contact Discharge (acc. IEC 61000-4-2)

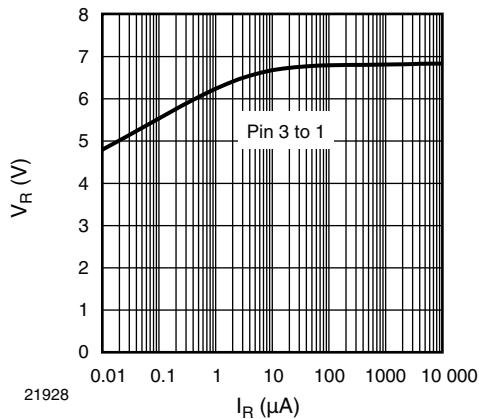

Fig. 5 - Typical Reverse Voltage V_R vs. Reverse Current I_R

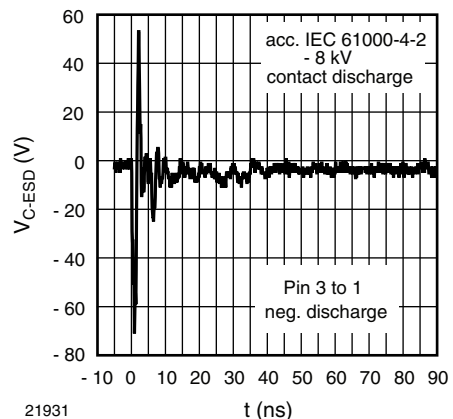

Fig. 8 - Typical Clamping Performance at -8 kV Contact Discharge (acc. IEC 61000-4-2)

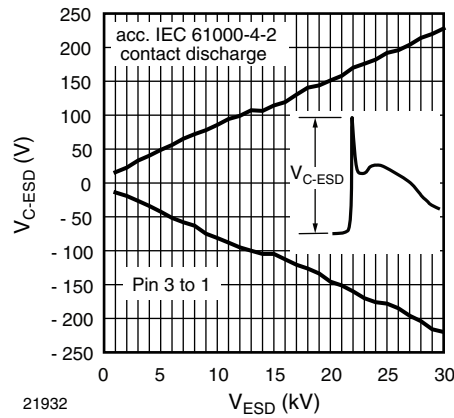
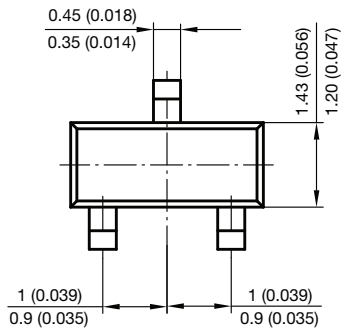
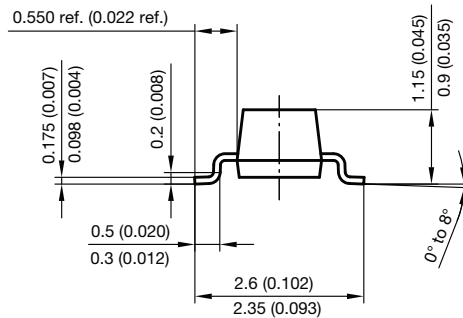
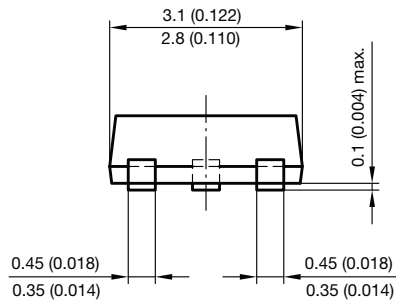
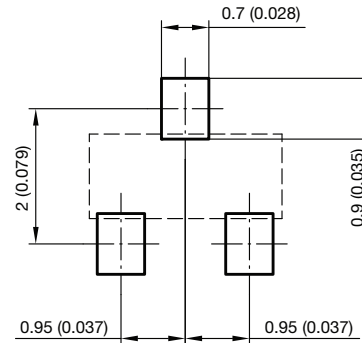

Fig. 9 - Typical Peak Clamping Voltage at ESD Contact Discharge (acc. IEC 61000-4-2)

PACKAGE DIMENSIONS in millimeters (inches): **SOT-23**



Foot print recommendation:



Document no.: 6.541-5014.01-4

Rev. 8 - Date: 23.Sept.2009

17418



Disclaimer

All product specifications and data are subject to change without notice.

Vishay Intertechnology, Inc., its affiliates, agents, and employees, and all persons acting on its or their behalf (collectively, "Vishay"), disclaim any and all liability for any errors, inaccuracies or incompleteness contained herein or in any other disclosure relating to any product.

Vishay disclaims any and all liability arising out of the use or application of any product described herein or of any information provided herein to the maximum extent permitted by law. The product specifications do not expand or otherwise modify Vishay's terms and conditions of purchase, including but not limited to the warranty expressed therein, which apply to these products.

No license, express or implied, by estoppel or otherwise, to any intellectual property rights is granted by this document or by any conduct of Vishay.

The products shown herein are not designed for use in medical, life-saving, or life-sustaining applications unless otherwise expressly indicated. Customers using or selling Vishay products not expressly indicated for use in such applications do so entirely at their own risk and agree to fully indemnify Vishay for any damages arising or resulting from such use or sale. Please contact authorized Vishay personnel to obtain written terms and conditions regarding products designed for such applications.

Product names and markings noted herein may be trademarks of their respective owners.